

San Antonio Water System Standard Specifications for Construction

ITEM NO. 812

Water Main Installation

812.1 DESCRIPTION: This item shall consist of water main installation in accordance with these specifications and as directed by the Engineer.

812.2 REFERENCE STANDARDS: Reference standards cited in this Specification Item No. 812 refer to the current reference standard published at the time of the latest logged revision date.

1. San Antonio Water System (SAWS):
 - a. Specifications for Water and Sanitary Sewer Construction
 - b. SAWS Materials Specifications
2. City Of San Antonio (COSA) Standard Specifications for Construction
3. Texas Commission of Environmental Quality (TCEQ) Chapter 290 Public Water Supply
4. American National Standards Institute (ANSI)/American Water Works Association (AWWA)
 - a. ANSI A 21.11/AWWA C111 - Standard for Rubber-Gasket Joints for Ductile-Iron Pressure Pipe and Fittings.
 - b. ANSI/NSF Standard 61 - Drinking Water System - Health Components.
 - c. ANSI/AWWA C151/A21.51—Ductile-Iron Pipe, Centrifugally Cast.
 - d. ANSI/AWWA C515—Reduced-Wall, Resilient-Seated Gate Valves for Water Supply Service (5.5 lb) Rammon and a 305 mm (12 in.) Drop.
 - e. ANSI/AWWA C105/A21.5—Polyethylene Encasement for Ductile-Iron
 - f. Pipe Systems.
 - g. ANSI/AWWA C111/A21.11—Rubber-Gasket Joints for Ductile-Iron Pressure Pipe and Fittings.
 - h. ANSI/AWWA C150/A21.50—Thickness Design of Ductile-Iron Pipe.
 - i. ANSI/AWWA C500—Metal-Seated Gate Valves for Water Supply Service.
 - j. ANSI/AWWA C509—Resilient-Seated Gate Valves for Water Supply Service.
 - k. ANSI/AWWA C651—Disinfecting Water Mains.
5. American Society for Testing and Materials (ASTM) International:
 - a. ASTM A 36 - Standard Specification for Carbon Structural Steel.
 - b. ASTM A 536 - Standard Specification for Ductile Iron Castings.
 - c. ASTM A 126 - Standard Specification for Gray Iron Castings for Valves, Flanges, and Pipe Fittings.
 - d. ASTM B 21 - Standard Specification for Naval Brass Rod, Bar, and Shapes.
 - e. ASTM B 98 - Standard Specification for Copper-Silicon Alloy Rod, Bar, and Shapes.

San Antonio Water System Standard Specifications for Construction

- f. ASTM B 301 - Standard Specification for Free-Cutting Copper Rod and Bar.
 - g. ASTM B 584 - Standard Specification for Copper Alloy Sand Casting for General Application.
 - h. ASTM E 165 - Standard Test Method for Liquid Penetrant Examination.
 - i. ASTM E 709 - Standard Guide for Magnetic Particle Examination.
 - j. ASTM F 1674 - Standard Test Method for Joint Restraint Products for Use with PVC Pipe.
 - k. ASTM D2241, “Poly(Vinyl Chloride) (PVC) Pressure-Rated Pipe (SDR PR Series)”
6. American Water Works Association (AWWA)
- a. AWWA C 206 - Standard for Field Welding of Steel Water Pipe.
 - b. AWWA C 207 - Standard for Steel Pipe Flanges for Waterworks Service - Sizes 4 Inches through 144 Inches.
 - c. AWWA C605, “Underground Installation of Polyvinyl Chloride (PVC) Pressure Pipe and Fittings for Water
 - d. AWWA C651-05 Disinfecting Water Mains
 - e. AWWA C900, “Polyvinyl Chloride (PVC) Pressure Pipe and Fabricated Fittings, 4 in. through 60in. (100 mm through mm) for Water Distribution”
 - f. AWWA C907, “Polyvinyl Chloride (PVC) Pressure Fittings for Water —4 in. through 8 In (100 mm Through 200 mm)
 - g. AWWA Manual M27, External Corrosion: Introduction to Chemistry and Control
 - h. AWWA M28 Rehabilitation of Water MainsAWWA Manual M41— Ductile-Iron Pipe and Fittings.
 - i. AWWA Manual M17, Installation, Field Testing, and Maintenance of Fire Hydrants.
7. International Organization of Standardization (ISO)
- a. ISO9001

812.3 SUBMITTALS: All submittals shall be in accordance with most recent version of SAWS’s General Conditions requirements. Submit the following prior to performing any work.

- 1. Certifications:
 - a. Per General Conditions section 5.12.2 all Contractor submittals for all pipe and other products or materials furnished under this specification shall be marked as reviewed and approved by Contractor for compliance with Contract Documents and the referenced standards.
 - b. The Manufacturer shall provide ISO 9001 Certificate by a third party.
 - c. Submit written verification that the pipe Manufacturer has been manufacturing pipe per required ASTM with similar design pressure and size as this Project.
 - d. Submit written verification from the pipe Manufacturer demonstrating compliance with the production and delivery schedule of the pipe as

San Antonio Water System Standard Specifications for Construction

- indicated in the Contractor's schedule.
- e. Submit written verification from mechanical fitting Manufacturer that fittings are compatible with proposed pipe and meets the requirements of this section.
2. Contractor shall submit Manufacturer's product data, installation recommendations, allowable deflection, shop drawings, and certifications.
 3. Shop Drawings:
 - a. Catalog Data Sheets for all materials confirming pipe, fittings, and other materials conform to requirements of this specification.
 - b. Pipe Supplier Information. Submit company name, contact name, and contact number.
 - c. Details of all piping systems components confirming that the pipe and fittings conform to the specified requirements.
 - d. The Contractor shall submit shop drawings of pipe, fittings, gaskets, hardware, flanges, appurtenances, special details sufficient to demonstrate compliance with these Specifications and applicable pipe installation Specification.
 - e. Fabrication drawings showing:
 - 1) Wall thickness.
 - 2) Pipe length.
 - 3) Pipe joint (i.e. mechanical, flanged. fused)
 4. Testing Plan: Submit at least prior to start of construction and at minimum, include the following:
 - a. Testing dates.
 - b. Piping systems and section(s) to be tested.
 - c. Method of isolation. Method of isolation to be approved by SAWS Inspector.
Method of conveying water from source to system being tested.
 - d. Hydrostatic leak testing.
 - i. Submit a hydrostatic leak testing plan which includes equipment (pump, water meter, pressure regulating valve, pressure gauges, etc.), water handling procedures (supply and disposal), sequence and schedule by test section, and pressure test data
 - ii. Certifications of Calibration: Approved testing laboratory certificate if pressure gauge for hydrostatic test has been previously used. If pressure gauge is new, no certificate is required.
 5. Testing Reports:
 - a. Furnish affidavit certified that all pipe meet the provisions of the specification and has been tested and submit reports in accordance with the applicable ASTMs and AWWA Standards. Reports to include the following:

San Antonio Water System Standard Specifications for Construction

- i. Hydrostatic proof test reports.
 - ii. Sustained pressure test reports.
 - iii. Burst strength test reports.
 - iv. Stress Regression Testing
 - v. Additional reports may be requested by SAWS Inspector
6. Fusion information as required by Specification Item No. 815 HDPE Installation.
7. The Contractor shall also submit details of welding/fusing procedures and equipment to be used.
8. Detail drawings indicating type, number, and other pertinent details of the slings and/or other methods proposed for pipe support and handling during manufacturing, transport, and installation. All pipe handling equipment and methods shall be acceptable to Owner.
9. Pipe Manufacturer's Written Quality Assurance/Quality Control Program.
10. Field Service Representative Resume.

812.4 MATERIALS: The materials for water main installation shall conform to the specifications contained within the latest revision of SAWS Material Specifications:

1. Material Specification Item No. 113-03: Specifications Ductile-Iron Restrained Joint Fittings for Use on Ductile Iron and Poly-Vinyl Chloride Pipe
2. Material Specification Item No. 05-11: Specifications Ductile Iron Pipe
3. Material Specification Item No. 05-12: Specifications for C-900 Polyvinyl Chloride (PVC) Pressure Pipe, 4-inch Through 12-Inch
4. Material Specification Item No. 05-13: Specifications for C909 Oriented Polyvinyl Chloride (PVC) Pressure Pipe, 4-Inch Through 12-Inch
5. Material Specification Item No. 05-20: Specifications for Prestressed Concrete Pressure Pipe Steel Cylinder Type
6. Material Specification Item No. 05-30: Specifications for Steel Water Pipe
Specification Item No. 815: Specifications for High Density Polyethylene Pipe
7. The pressure rating for pipe materials apply to any work performed in SAWS Pressure Zones. Minimum pressure rating for all pipes shall be 235 psi, or as identified in plans and bid documents.
8. PVC water pipe shall be blue in color. **White PVC pipe is not permitted.**
9. PVC Water pipe sizes greater than 24" shall not be allowed. PVC pipe markings shall include:
 - a. Manufacturer's name or trademark;
 - b. Standard to which it conforms;
 - c. Pipe size;
 - d. Material designation code;
 - e. Pressure rating;
 - f. SDR number or schedule number;

San Antonio Water System Standard Specifications for Construction

- g. Potable water laboratory seal or mark attesting to suitability for potable water;
- h. A certifier's mark may be added; and
- i. Manufactured date (installation shall not exceed one year from this date)

812.5 CONSTRUCTION:

1. The Contractor shall start his work near a tie-in or point designated by the Inspector.
2. Pipe shall be laid with bell ends facing in the direction of pipe laying, unless otherwise authorized or directed by the Inspector.
3. All valves and fire hydrants must be installed as soon as pipe laying reaches their established location.
4. All pipe shall be installed to the required lines and grades with fittings, valves, and hydrants placed at the required locations.
5. Spigots shall be centered in bells or collars, all valves and hydrant stems shall be set plumb, and fire hydrant nozzles shall face as per SAWS standard details..
6. No valve or other control on the existing system shall be operated for any purpose by the Contractor unless a representative of SAWS is present.
7. New water mains crossing any other utility shall have a minimum of 5 feet of cover over the top of the pipe, unless otherwise waived or modified by the Engineer.
8. Excavation around other utilities shall be done by hand for at least 12 inches all around.
9. Any remedial measures for damages will be at Contractors expense.
10. Any damage to the protective wrap on gas lines or electrodes shall be reported immediately to the CPS Energy, phone (210) 353-4357.
11. Any damage to other utilities shall be reported to their proper governing entity.
12. In any case of utility damage, the Contractor shall also promptly notify the Inspector.
13. Any remedial measures for damages will be at Contractor's expense.
14. New waterline installation and separation shall comply with TCEQ Chapter 290; Subchapter D – Rules and Regulations for Public Drinking Water criteria for the location and installation of waterlines. See Drawings series DD-812.
15. All separation distances shall be measured from the outside surfaces of each of the respective pieces.
16. The bedding and backfill of the existing wastewater mains or laterals shall not be disturbed.
17. All water mains shall have a minimum of 5 feet of cover from the proposed final finish ground/street/elevation unless otherwise adjusted by the Engineer.
18. Pipe grades shall be as required by the contract documents or as directed by the Engineer.
19. Precaution shall be taken to ensure that the pipe barrel has uniform contact with the cushion material for its full length except at couplings.
20. The couplings shall not be in contact with the original trench bottom prior to

San Antonio Water System Standard Specifications for Construction

- backfilling.
21. Cushion material shall be placed under the coupling and compacted by hand prior to backfilling so as to provide an even bearing surface under the coupling and pipe.
 22. Prior to placing pipe in a trench, the trench shall have been excavated to the proper depth as required in plans and Specification Item No. 804 "Excavation, Trenching, and Backfilling."
 23. Approved imported materials or Engineer-approved native materials, as per Specification Item No. 804 "Excavation, Trenching, and Backfilling," shall be smoothly worked across the entire width of the trench bottom to provide a supporting cushion.
 24. When either the Inspector or Engineer note that the material at the bottom of a trench is unstable or unsuitable, it shall be removed and replaced with approved material which may be properly compacted in place to support the pipe. See Specification Item No. 804 "Excavation, Trenching, and Backfilling,"
 25. If required the Contractor shall also construct a foundation for the pipe consisting of piling, concrete beams, or other supports in accordance with contract documents prepared by the Engineer.
 26. Proper implements, tools, and facilities satisfactory to the Inspector shall be provided and used by the Contractor for the safe and convenient completion of work.
 27. All pipe, fittings, valves, and hydrants shall be carefully lowered into the trench piece by piece, by means of a derrick, ropes, or other suitable tools or equipment in such a manner as to prevent damage to water main materials and protective coatings, polywrap sleeving, and linings.
 28. Under no circumstances shall water main materials, pipes, fittings, etc., be dropped or dumped into the trench.
 29. Extreme care shall be taken to avoid damaging polywrap films. No chains or slings shall be allowed unless the entire sling is wrapped with a protective nylon web sock.
 30. To prevent pipe damage, proper implements, tools, and equipment should be used for placement of the pipe in the trench; pipe and/or accessories should never be dropped into the trench.
 31. After placing a length of pipe in the trench, the jointed end shall be centered on the pipe already in place, forced into place, brought to correct line and grade, and completed in accordance with requirements.
 32. The pipe shall be secured in place with approved initial backfill material tamped around it.
 33. Precautions shall be taken to prevent dirt or other foreign matter from entering the joint space.
 - a. Under adverse trenching conditions, work stoppage for more than 24 hours and/or as otherwise required by the Inspector, a manufactured water tight cap/plug is to be used at each end to prevent any foreign type material entering the pipe and to make the pipe watertight.

San Antonio Water System Standard Specifications for Construction

- b. This provision shall apply during all periods when pipe laying is not in progress.
 - c. Should water enter the trench, the seal shall remain in place until the trench is pumped completely dry.
 - d. The Contractor shall provide all plugs and caps of the various sizes required.
 - e. The cap/plug shall be left in place until the pipe is connected to an adjacent pipe.
 - f. The interior of each pipe shall be inspected for foreign material or defects, and the pipe shall be cleaned or rejected if any defects are found.
34. Deviations in Alignment
- a. Wherever obstructions not shown in the contract documents, to include changes in depth and/or alignment, are encountered during the progress of the work and interfere to an extent that an alteration in the plan is required, the Engineer shall have the authority to change the contract documents and direct a deviation from the alignment or to arrange with the owners of the structures for the removal, relocation, or reconstruction of the obstructions.
 - b. Any deviation from the alignment shall be accomplished by the use of appropriate bends unless such requirement is specifically waived by the Engineer.
 - c. These deviations shall clearly and accurately be reflected in the Contractor's submittal of their redline drawings for permanent recording purposes.
 - d. Whenever it is necessary to deflect pipe from a straight line, the deflection shall be as directed by the Engineer.
 - e. In no case shall the amounts shown in Table 1, Maximum Deflections of Ductile Iron Pipe, or Table 2, Maximum Deflections of Concrete Steel Cylinder Pipe, or as per manufacture's recommendation for pipe deflection be exceeded.
 - f. If deflection is exceeded, bends must be incorporated.
 - g. Deflection of PVC (C-900, and C-909) shall be limited to 1 degree of the manufacturers recommended deflection as noted in specification 818 Water Pipe Installation PVC (C-900, and C-909) Pipe 4 inch to 24 in Pipe
 - i. Changes in direction of PVC pipe shall only be use of fittings or by deflecting straight pipe sections at joints.
 - ii. Longitudinal bending of pipe is not allowed
 - iii. Deflection of pipe fittings is not allowed
 - iv. Deflection of straight pipe sections shall not exceed 1 degree at each joint (even if joint restraint devices are installed), which corresponds to the following in pipe alignment:
 - 1) Length of pipe, feet offset, inches allowable radius of cuvature, feet
204 maxium, feet 1,1146 minimum

San Antonio Water System Standard Specifications for Construction

TABLE 1					
MAXIMUM DEFLECTIONS OF DUCTILE-IRON					
Nominal Pipe Diameter	Maximum Deflection Angle	Maximum Deflection In Inches		Approximate Radius Of Curve In Inches	
		18 Ft.	20 Ft.	18 Ft.	20 Ft.
6"	4°25'	16.7	18.5	234	260
8"	3°51'	14.6	16.2	268	297
10"	3°42'	14.0	15.5	279	310
12"	3°08'	11.9	13.2	327	363
16"	2°21'	8.8	9.7	440	488
20"	1°55'	7.2	8.0	540	600
24"	1°35'	6.0	6.7	648	720

San Antonio Water System Standard Specifications for Construction

TABLE 2					
MAXIMUM DEFLECTIONS OF CONCRETE STEEL CYLINDER					
Nominal Pipe Diameter	Maximum Deflection Angle	Maximum Deflection In Inches		Approximate Radius Of Curve In Inches	
		16 Ft.	20 Ft.	16 Ft.	20 Ft.
16"	2°20'	--	9.8	--	500
20"	1°52'	--	7.8	--	600
24"	1°34'	--	6.6	--	750
30"	1°16'	--	5.3	--	900
36"	1°02'	--	4.3	--	1100
42"	0°54'	--	3.8	--	1300
48"	0°47'	2.6	--	1170	--
54"	0°44'	2.5	----	1237	--
60"	0°54'	3.0		1024	-

35. Cutting Pipe:
- a. The cutting of pipe for inserting valves, fittings, or closure pieces shall be accomplished in a neat and workmanlike manner so as to produce a smooth end at right angles to the axis of the pipe.
 - b. The recommendations of the pipe manufacturer shall be strictly followed by the Contractor.
 - c. Only qualified and experienced workmen shall be allowed to cut pipe and, under no circumstances, shall a workman not equipped with proper safety goggles, helmet and all other required safety attire be permitted to engage in this work.
 - d. All cuts made on ductile-iron pipe shall be done with a power saw.
 - i. The cuts shall be made at right angles to the pipe axis and shall

San Antonio Water System Standard Specifications for Construction

- ii. be smooth.
 - ii. The edges of the cut shall be finished smoothly with a hand or machine tool to remove all rough edges.
 - iii. The outside edge of pipe should be finished with a small taper at an angle of about 30 degrees.
 - iv. Solid sleeves or cast couplings shall be allowed on precast/prefab vaults only.
 - v. All fire line services shall be installed with full joints of pipe.
 - e. **Tapping of CSC pipe is only allowed by CSC Manufacturer of pipe brand being tapped or CSC Manufacturer approved by SAWS. See Specification Item No. 820 Concrete Steel Cylinder Pipe Installation.**
 - f. To facilitate future repair work on water mains, no sections less than 3 feet in length between fittings shall be allowed.
 - g. Asbestos Cement (AC): No field cutting, breaking, or crushing will be allowed on AC pipe.
 - i. Repairs to AC pipe shall be accomplished by removing one full joint of AC pipe and replacing with appropriate PVC, Ductile Iron pipe, CSC, or HDPE pipe and fittings.
 - ii. All work associated with removing and disposing of AC pipe shall conform to the provisions of Item No. 3000, "Handling of Asbestos Cement Pipe."
36. Joint Assembly:
- b. Rubber Gasketed Joints: The installation of pipe and the assembly of rubber gasketed joints for ductile iron pipe, PVC, HDPE, CSC pipe shall conform to the pipe manufacturer's assembly instructions.
 - c. The method of inserting spigot ends of pipe in bells or collars known as "stabbing" shall not be permitted with pipe larger than 6 inches in size.
 - d. Spigot ends of pipe larger than 6 inches in size must be properly inserted in the joint by means of suitable pushing/pulling devices or an approved manufacture's method.
 - e. PVC spigot ends shall be pushed in until the lip of the bell is between the reference marks on the spigot end.
 - i. If the spigot is inserted beyond the insertion point, the pipe will have to be pulled out and reinserted.
 - ii. Pipe should be inspected to ensure pipe has not been damaged prior to reinsertion.
 - iii. Any damaged pipe shall be replaced at Contractors expense.
 - f. Mechanical couplings shall be assembled and installed according to the standards recommended by the manufacturer.
 - i. Prior to the installation of the mechanical coupling, the pipe ends shall be cleaned by wire brush or other acceptable method to provide a smooth bearing surface for the rubber compression gasket.
 - ii. The pipe shall be marked to align the end of the coupling which will center it over the joint.

San Antonio Water System Standard Specifications for Construction

- iii. After positioning, the nuts shall be drawn up finger tight.
 - iv. Uniform pressure on the gaskets shall be applied by tightening alternate bolts on the opposite side of the circle in incremental amounts.
 - v. Final tensioning shall be accomplished with a torque wrench and in a manner similar to the tightening procedure.
 - vi. Final torque check shall then be made prior to coating and wrapping the joint.
 - vii. Refer to manufacturer's recommendations for proper torque.
 - g. Restraint Joints shall be installed as shown on the contract documents or as directed by the Engineer.
 - a. Installation shall conform to the manufacturer's recommendation.
 - b. Refer to Specification Item No. 839 Anchorage/Thrust Blocking and Joint Restraints.
37. Abandonment/Removal of Existing Mains:
- a. The Contractor shall accomplish all cutting, capping, plugging, and blocking necessary to isolate existing mains retained in service from abandoned mains.
 - b. The open ends of abandoned mains and all other openings or holes in such mains occasioned by cutting or removal of outlets shall be blocked off by pressure forcing cement grout or concrete into and around the openings in sufficient quantity to provide a permanent substantially watertight seal.
 - c. Abandonment of existing water mains will be considered subsidiary to the work required, and no direct payment will be made.
 - d. Capping or plugging of main is preferred over grouting. For mains 12" and larger, under major thoroughfare or highways, grouting will be required.
 - e. When specified or shown otherwise in the contract documents, Contractor shall remove the main and all related appurtenances that are to be replaced, or will no longer be in service, and all effort to accomplish this requirement will be considered subsidiary to the work required, and no direct payment will be made.
 - f. Removed AC pipe shall be manifested and disposed of in accordance with Item No. 3000, "Handling Asbestos Cement Pipe."
- Valves abandoned in the execution of the work shall have the valve box and extension removed in its entirety and filled with flowable fill to within 12" inches of the surface.
- a. The remaining 12" inches shall be filled with required asphaltic pavement or top soil and sod and finished flush with the adjacent pavement or ground surface as required (N.S.P.I.).
- At no time during the project work shall any valves be covered or rendered inaccessible for operation due to any activities by the Contractor.
39. Any work during construction activities will be suspended until this requirement is met.
40. No claims for cost or schedule delays will be accepted.

San Antonio Water System Standard Specifications for Construction

812.6 MEASUREMENT:

1. Water main installed will be measured by the linear foot for each size and type as follows:
 - a. Measurements will be from the center line intersection of runs and branches of tees to the end of the valve of a dead end run.
 - b. Measurements will also be between the center line intersection of runs and branches of tees.
 - c. Where the branch is plugged for future connection, the measurement will include the entire laying length of the branch or branches of the fitting.
 - d. The measurement of each line of pipe of each size will be continuous and shall include the full laying lengths of all fittings and valves installed between the end of such line except that the laying length of reducers will be divided equally between the connected pipe sizes.
 - e. Lines leading to a tapping connection with an existing main will be measured to the center of the tapped main.

812.7 PAYMENT: Payment for water main installed will be made at the unit price bid per linear foot of pipe of the various sizes installed by the open cut method.

1. Such payment shall also include excavation, concrete encasement, pipe encasement, spacers, grout, selected embedment material, backfill, compaction, compaction testing, polyethylene sleeve, fittings, adapters, couplings, anchors, cathodic protection if required, tracer wire and detection tape if required, hauling and disposition of surplus excavated material, including all existing pipe, fittings, appurtenances to be abandoned or removed, installation of all weather surface, and other required testing as per Specification Item No. 804, "Excavation, Trenching, and Backfilling,"
2. Materials paid on site will be in accordance with Table 1 of Specification Item No. 100 Mobilization.

-End of Specification-

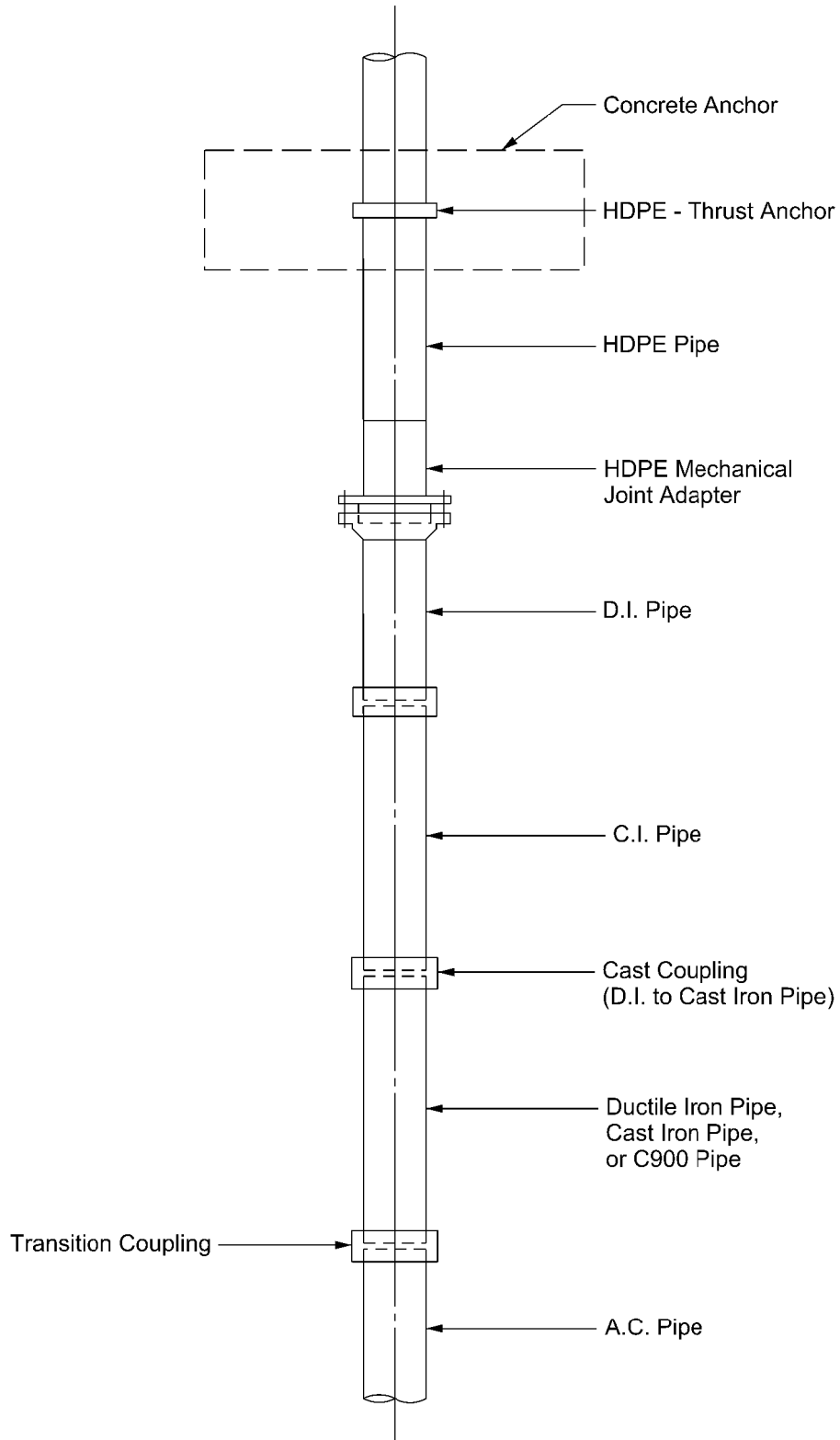

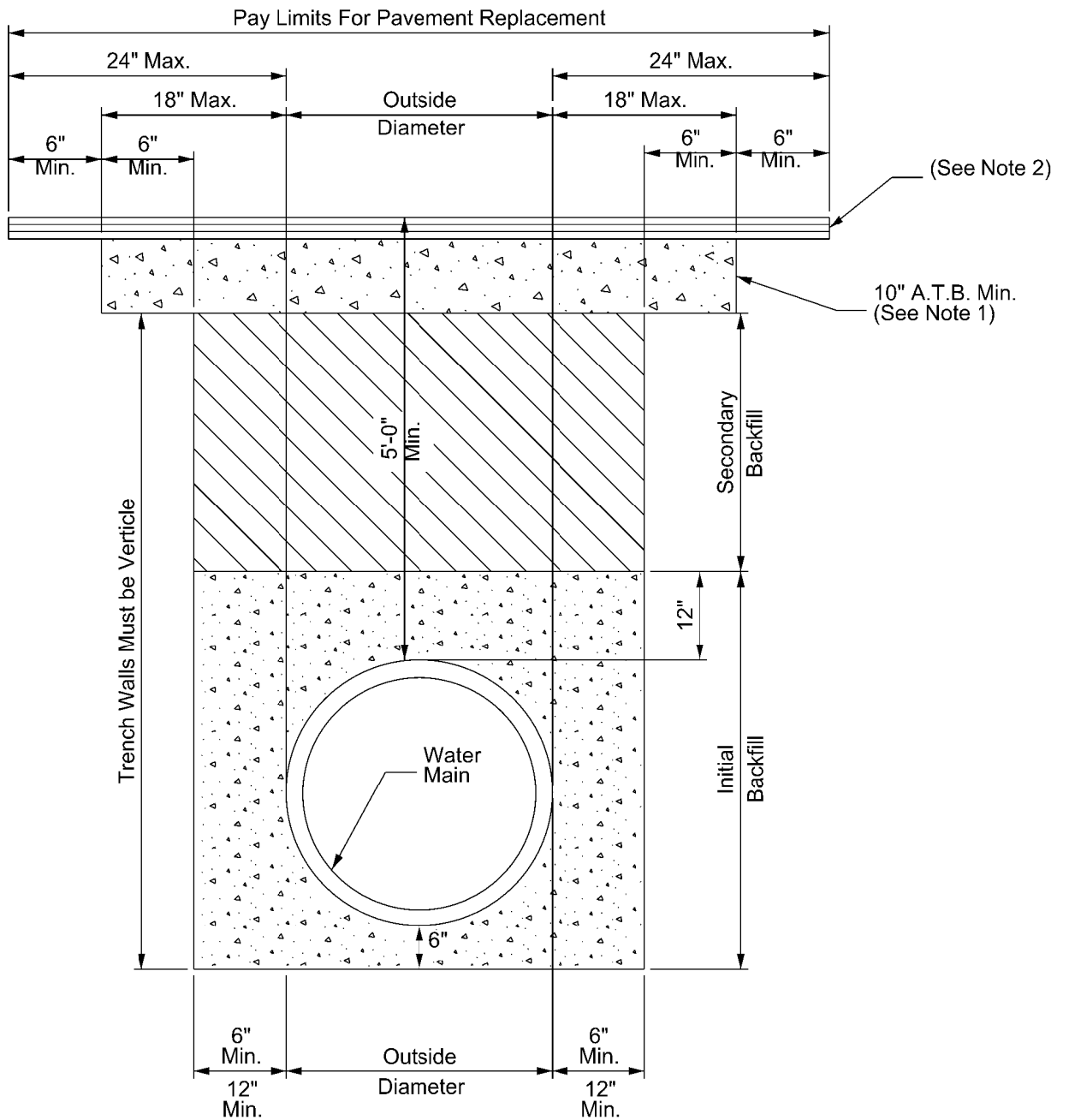

1. Asphalt Treated Base - As Specified COSA ROW - 10" Min. or Greater.

2. Replacement of Surface Layer Shall be of the Type and Thickness Base On Functional Classification.

- a. Min 2" HMAC Type "D" for Trench Repair in Local / Residential Streets.
- b. Min. 3" HMAC Type "C" for Trench Repair in Collector / Arterial Streets.

- Asphalt Treated Base (ATB)
- Hot Mix Asphalt Concrete (HMAC)

PROPERTY OF
SAN ANTONIO WATER SYSTEM
SAN ANTONIO, TEXAS

POTABLE AND RECYCLED
WATER MAIN DETAIL

APPROVED
MARCH 2008

REVISED
AUG 2019

DD-812-01

SHEET
2 OF 9

EXISTING / NEW WATER LINES CONSTRUCTED
LOCATION OF WATER LINES

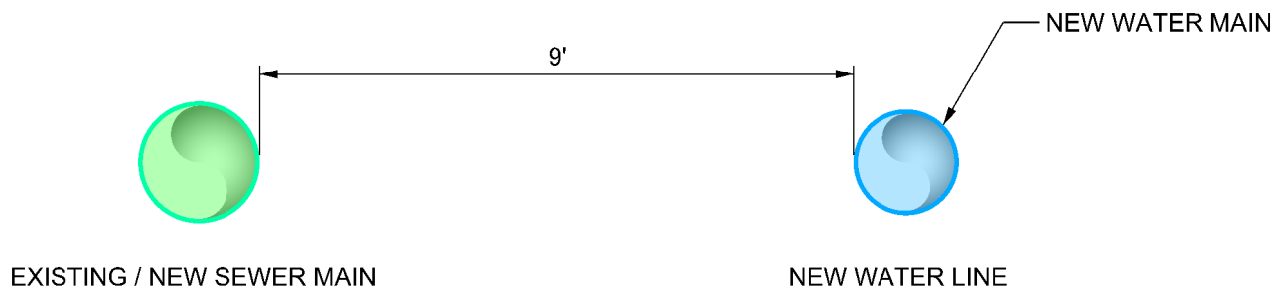

Where the nine foot separation distance can not be achieved, the following criteria shall apply: LOCATION OF WATER LINES - PARRALLEL LINE

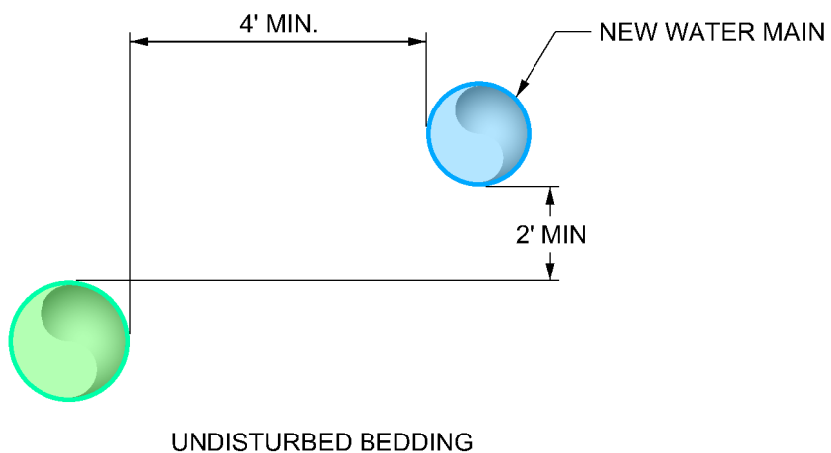

NEW WATER LINE CROSSES AN EXISTING NON-PRESSURE RATED WASTEWATER MAIN: NEW WATERLINE INSTALLATION - CROSSING LINES

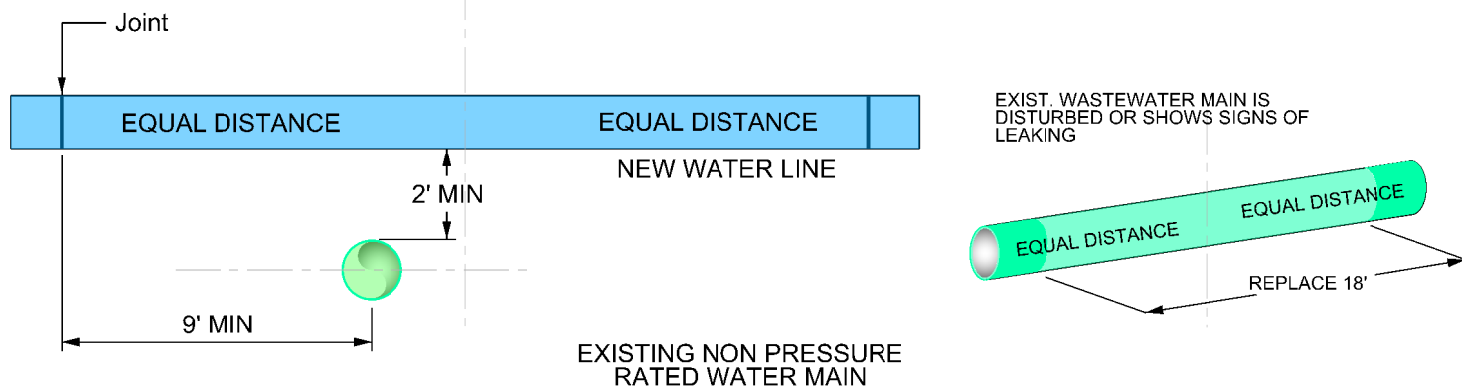

NEW WATER LINE CROSSES AN EXISTING PRESSURE RATED WASTEWATER MAIN
LOCATION OF WATER LINES - CROSSING LINES

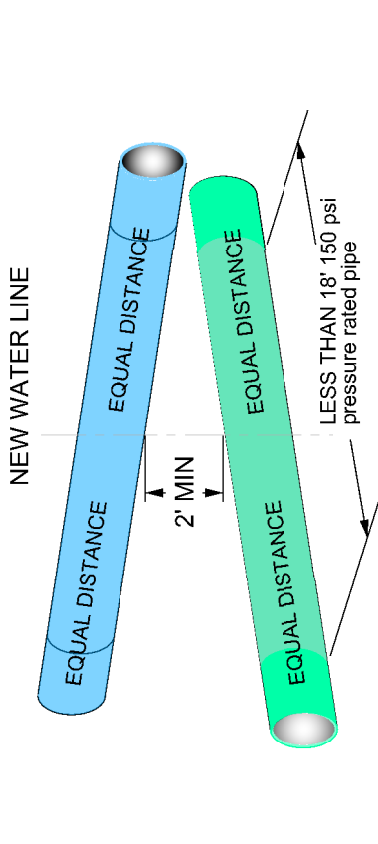
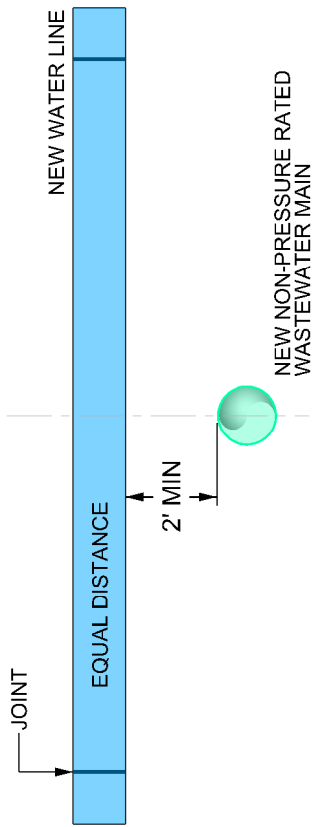

NEW NON-PRESSURE RATED WASTEWATER MAIN

NEW WATERLINE CROSSES A NEW PRESSURE RATED WASTEWATER MAIN
LOCATION OF WATER LINES - CROSSING LINES

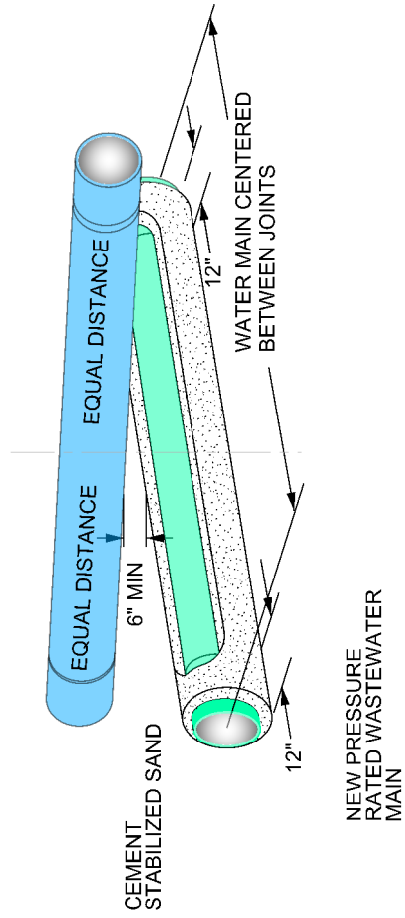
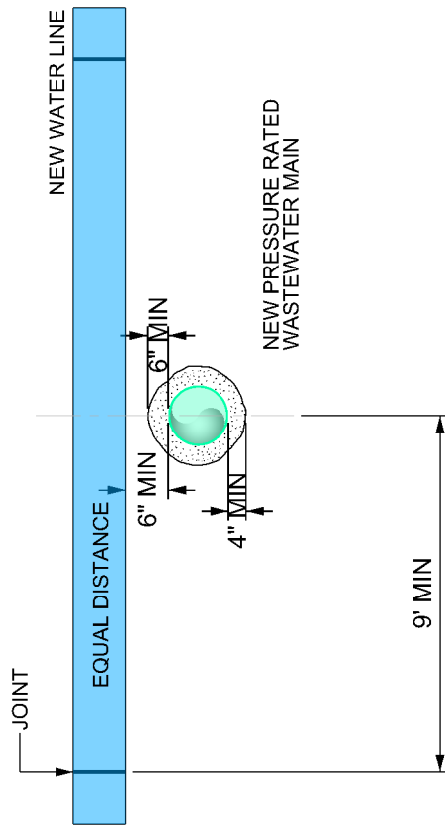

NEW PRESSURE RATED WASTEWATER MAIN

NEW WATER LINE CROSSES A NEW NON PRESSURE RATED WASTEWATER MAIN
 LOCATION OF WATER LINES - CROSSING LINES

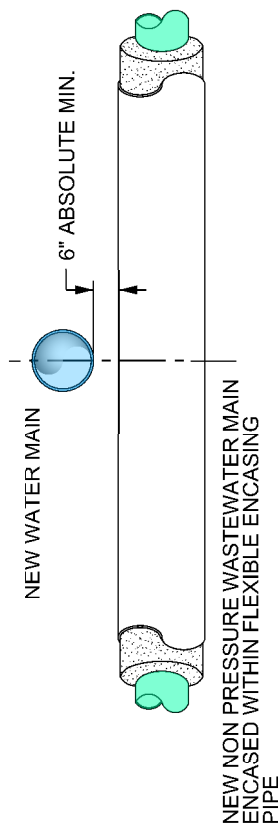

LOCATION OF WATER LINES - CROSSING LINES

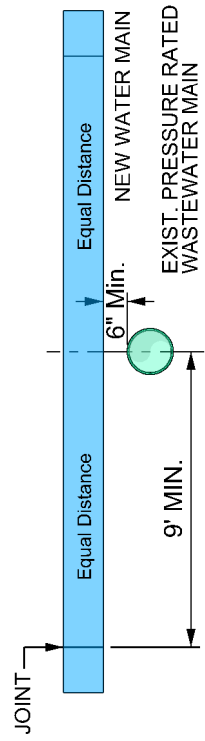

NEW WATER LINE CROSSES A NEW NON-PRESSURE RATED WASTEWATER MAIN

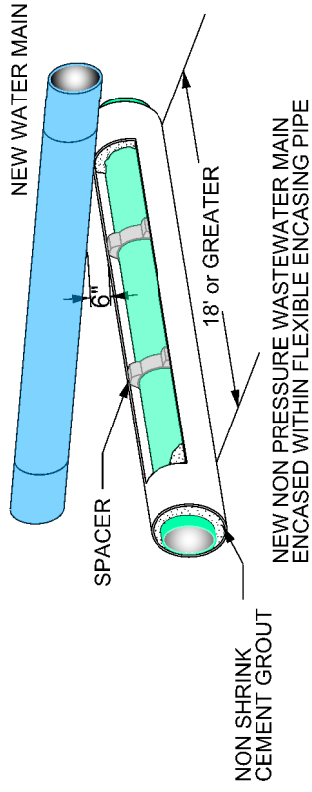
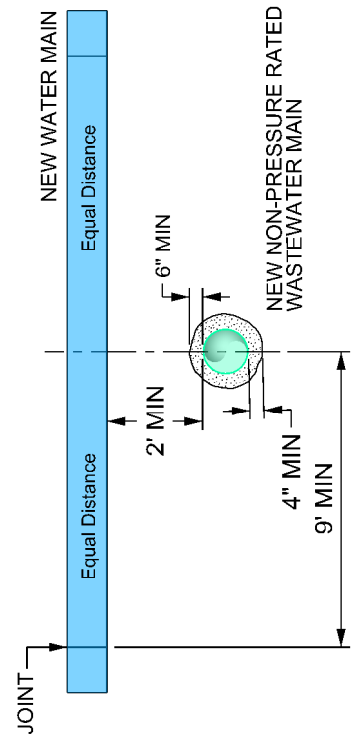

NEW NON PRESSURE WASTEWATER MAIN
 ENCASED WITHIN FLEXIBLE ENCASING PIPE

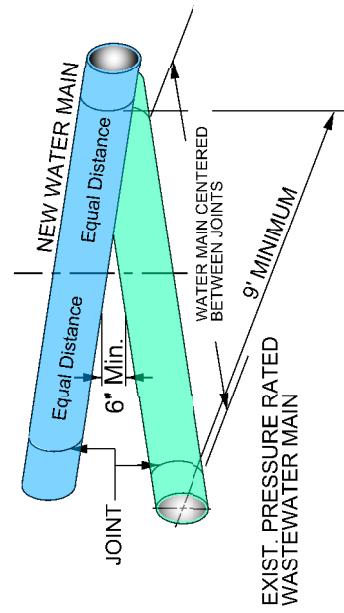

EXIST. PRESSURE RATED
 WASTEWATER MAIN

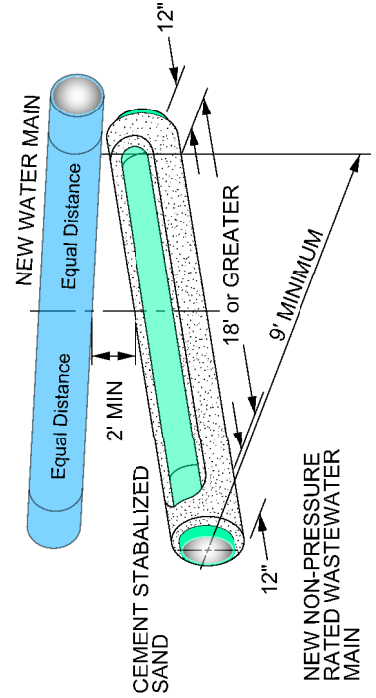

NEW NON-PRESSURE
 RATED WASTEWATER
 MAIN

NEW WATER LINE CROSSES UNDER A WASTEWATER MAIN
 LOCATION OF WATER LINES - CROSSING LINES

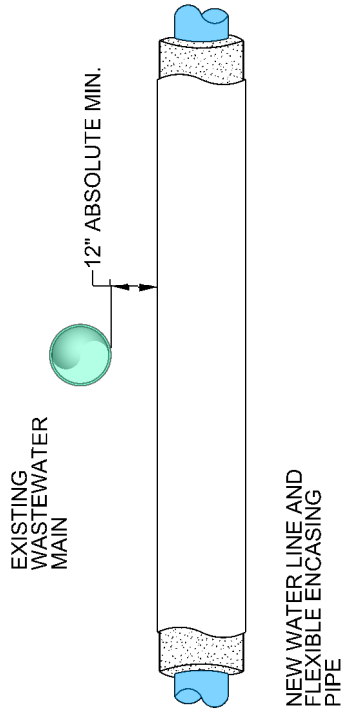
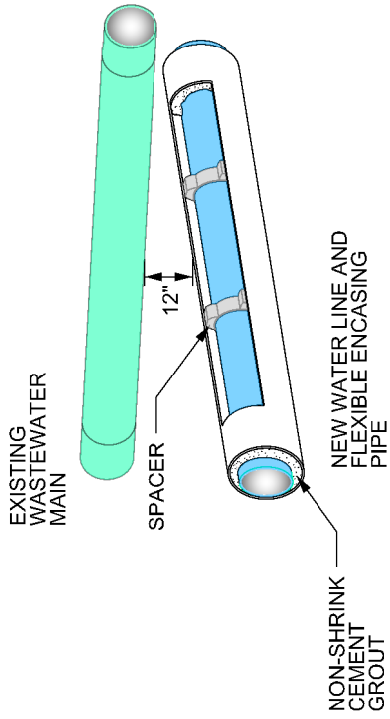

WATERLINE AND WASTEWATER MAIN OR LATERAL MANHOLE OR CLEANOUT SEPARATION
 CLEANOUT SEPARATION

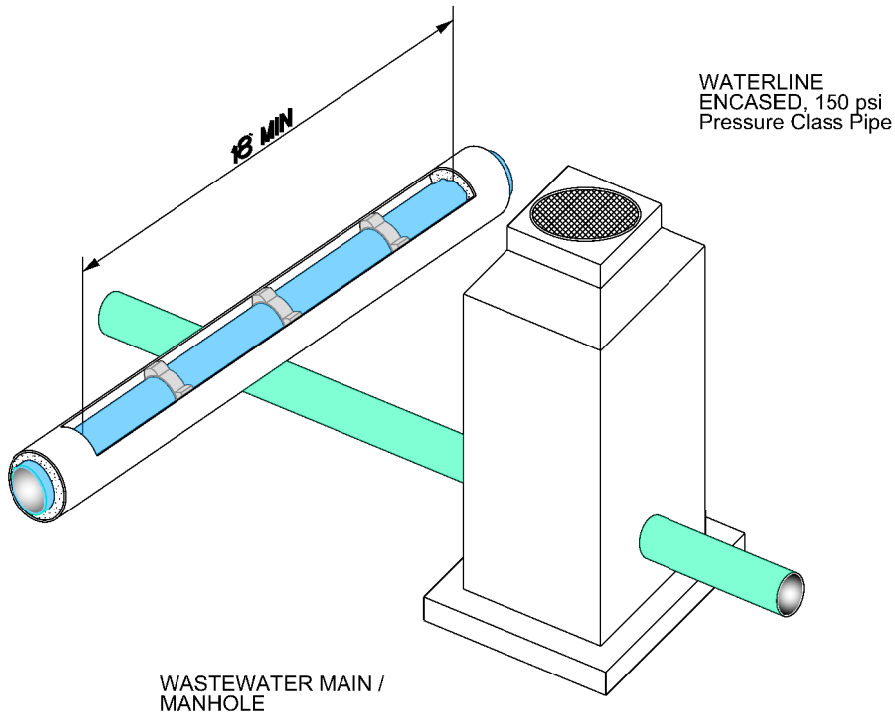
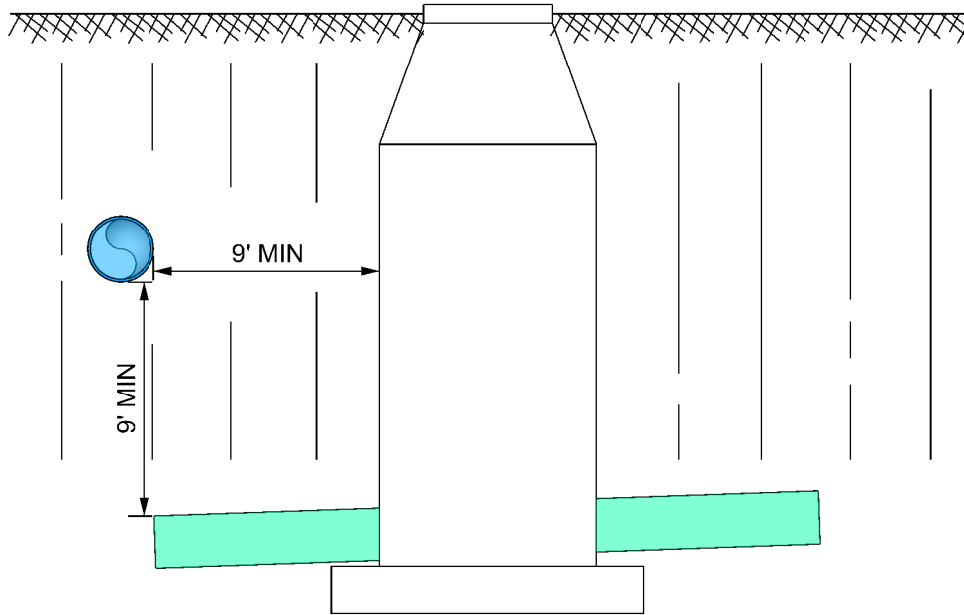

WATERLINE AND WASTEWATER MAIN OR LATERAL MANHOLE OR CLEANOUT SEPARATION
 LOCATION OF FIRE HYDRANTS

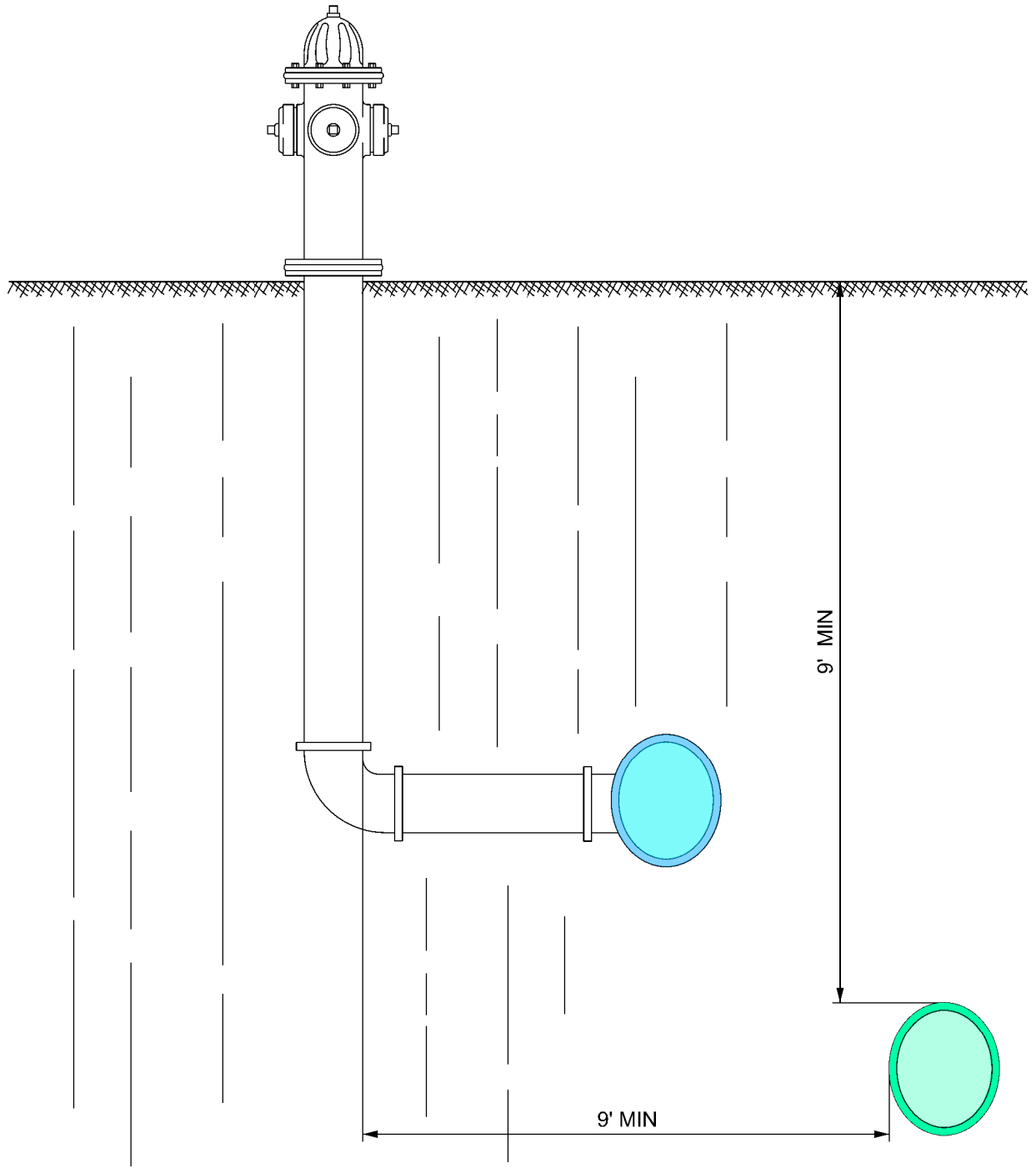

PROPERTY OF SAN ANTONIO WATER SYSTEM SAN ANTONIO, TEXAS	FIRE HYDRANT WITH MAIN GREATER THAN 6 FOOT DEPTH	APPROVED	REVISED
			AUG 2019
		DD-812-01	SHEET 8 OF 9

SANITARY SEWER RELIEF LINE

RELIEF SEWERS - AN OVERLOADED EXISTING SANITARY SEWER MAY REQUIRE RELIEF, WITH THE RELIEF SEWER CONSTRUCTED PARALLEL TO THE EXISTING LINE TO DIVERT FLOWS TO ALTERNATE OUTLETS.

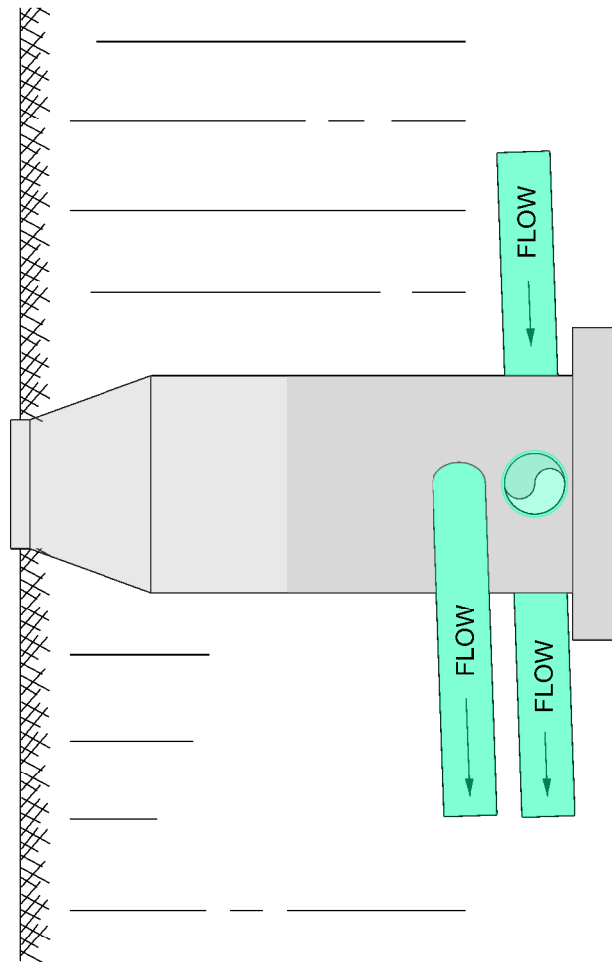

ELEVATION VIEW - SEWER RELIEF LINE

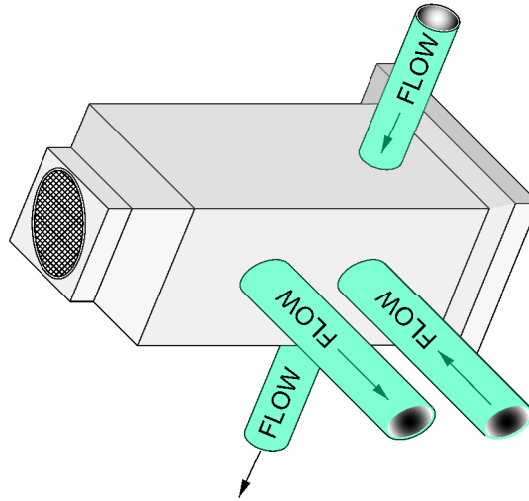

ISOMETRIC VIEW - SEWER RELIEF LINE