

**San Antonio Water System Standard Specifications for Construction**

**ITEM NO. 839**

**Anchorage/Thrust Blocking And Joint Restraint**

**839.1 DESCRIPTION:** This item shall consist of anchorage/thrust blocking installation and adjustment, in accordance with these specifications and as directed by the Engineer. Pipe restraint devices shall be installed according to the lengths prescribed herein or as noted in the contract documents, whichever is more restrictive.

**839.2 REFERENCED STANDARDS:** Reference standards cited in this Specification Item No. 839 refer to the current reference standard published at the time of the latest revision date logged at the end of this Specification Item No. 839 unless a date is specifically cited.

1. San Antonio Water System (SAWS):
  - a. Specifications for Water and Sanitary Sewer Construction
  - b. SAWS Materials Specifications
2. City Of San Antonio (COSA) Standard Specifications for Construction

**839.3 MATERIALS:** The materials for anchorage/thrust blocking installation shall conform to the appropriate specifications contained within the latest revision of SAWS Material Specifications.

Pipe restraint devices shall conform to the latest revision of SAWS Material Specification Item Nos. 95-10 and 113-02.

**839.4 CONSTRUCTION:** Suitable anchorage/thrust blocking or joint restraint shall be provided at all of the following main locations: dead ends, plugs, caps, tees, crosses, valves, and bends, in accordance with the Standard Drawings DD-839 Drawing Series.

1. All mechanical (joint) restraints shall be bidirectional. Anchor blocks shall be constructed solidly behind the fitting and symmetrical with the axis of resultant thrust, except where this is not possible as in the case of gravity anchorage for vertical bends.
2. Special ties and anchor fittings may be utilized in conjunction with blocking when shown in the contract documents or as directed by Engineer or Inspector.
3. All thrust blocking shall be a minimum of 3,000 psi concrete placed between solid ground and the fitting except as otherwise shown in the contract documents.
4. The area of bearing in contact with solid ground shall be that shown in the contract documents or as directed by the Engineer.
5. All thrust blocking placed in conjunction with mains and appurtenances shall be in accordance with Standard Drawings DD-839 Series.
6. In all cases, the design of thrust blocking shall be of sufficient size to withstand an assumed soil lateral load bearing capacity of 3,000 psf, unless specified otherwise in the contract documents.
7. When specifically requested by the Contractor and approved by the Engineer, the maximum soil lateral load bearing capacity that will be allowed for the design of thrust blocking shall be 5,000 psf.

## **San Antonio Water System Standard Specifications for Construction**

8. When soil lateral load bearing capacities of 4,000 psf or 5,000 psf are recorded for design of thrust blocks, copies of soil tests made for determining the lateral load bearing capacity of the subject soil shall be submitted to the Engineer for approval.
9. The blocking shall be placed so that pipe and fitting joints will be accessible.
10. Pipe polywrap shall be placed between the pipe or fitting and the concrete.
11. The reaction block on the unused branch of a fitting shall be poured separately from the block across the back of the fitting. If they are poured simultaneously, a rigid partition shall be placed between the blocks.
12. Valves 12 inches or larger in size shall be supported on a concrete pad extending vertically from 12 inches below the bottom of the valve to the lower quarter point of the hub and laterally from face to face of hubs and transversely from wall to wall of the trench.
13. All joints for carrier pipe installed within casing shall be restrained.

**839.5 MEASUREMENT:** Anchorage/Thrust Blocking or Joint Restraints are considered subsidiary to the work and no separate payment will be made to the Contractor for this work.

**839.6 PAYMENT:** Anchorage/Thrust Blocking or Joint Restraints are considered subsidiary to the work and no separate payment will be made to the Contractor for this work.

**End of Specification**

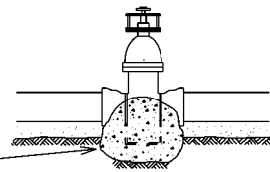
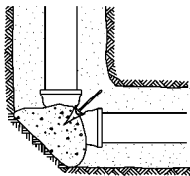
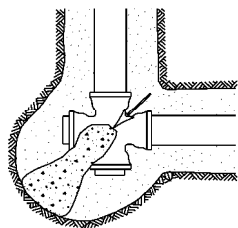
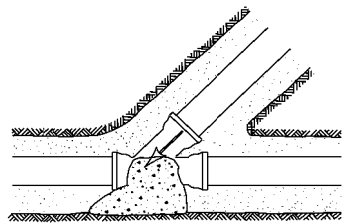
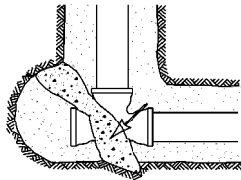
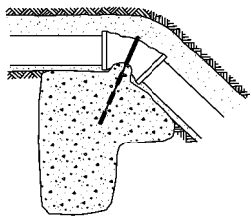
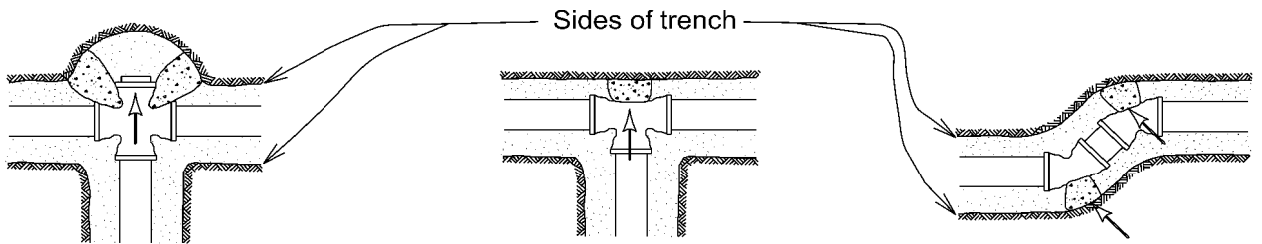

Concrete blocking required for all 12" & larger, except in high pressure distribution system where blocking is required for all valves

Select Material

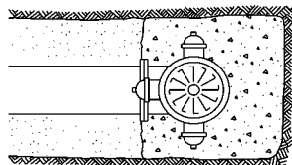

PLAN

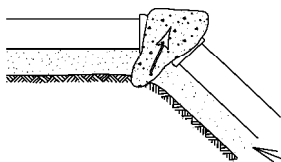

Select Material

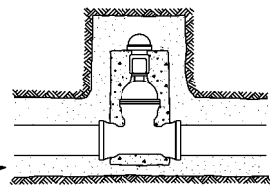

PLAN

Pour base after Hydrant has been placed

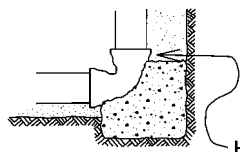

ELEVATION

Hydrant Drain

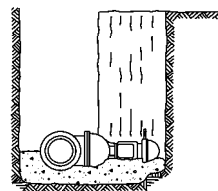
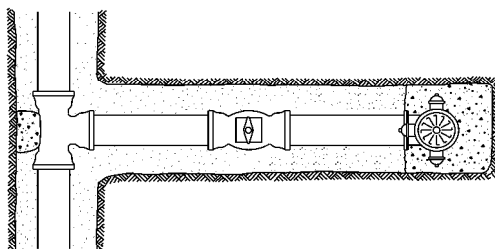

ELEVATION

Typical blocking for 90° Bend

Area in Sq. Ft. for each of the following pipe sizes

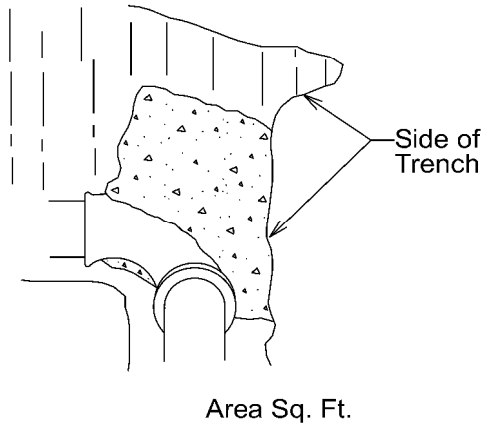

### THRUST BLOCKING DESIGN

On basis of 200 psi water pressure used for tests, the blocking required for two types of soils are noted below. In one case, a soil pressure of 5000 psf is used for rock excavation and for soils other than rock a 3000 psf bearing soil pressure is used. The distribution on system is pressure of 175 psf all calculations apply to A.C. Pipe Class 200 and Ductile Iron Pipe Class 2. PVC Pipe Class 200 (SDR 13.5)

2 Sq. Ft. in rock & 4 Sq. Ft. in other soils

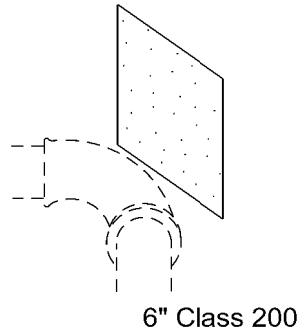

Area Sq. Ft.

4 Sq. Ft. in rock & 6 Sq. Ft. in other soils

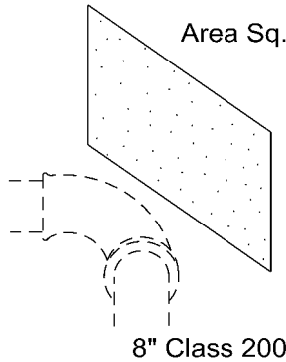

Area Sq. Ft.

9 Sq. Ft. in rock & 14 Sq. Ft. in other soils

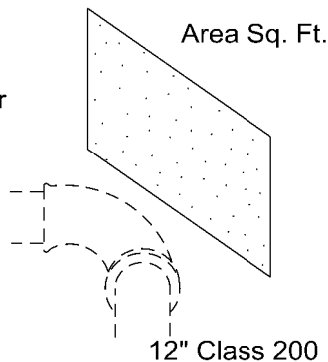

Area Sq. Ft.

Blocking area for 200 psi tests & 175 psi working pressures.

#### Square feet of blocking required for rock excavation

SIZE PIPE	TEES & DEAD ENDS	90° BENDS	45° BENDS	22 1/2° BENDS
6"	2	2	1	1
8"	3	4	2	1
12"	6	9	5	2
16"	11	15	8	4

#### Square feet of blocking required for other than rock excavation

SIZE PIPE	TEES & DEAD ENDS	90° BENDS	45° BENDS	22 1/2° BENDS
6"	3	4	2	1
8"	4	6	4	2
12"	10	14	8	4
16"	18	25	14	7

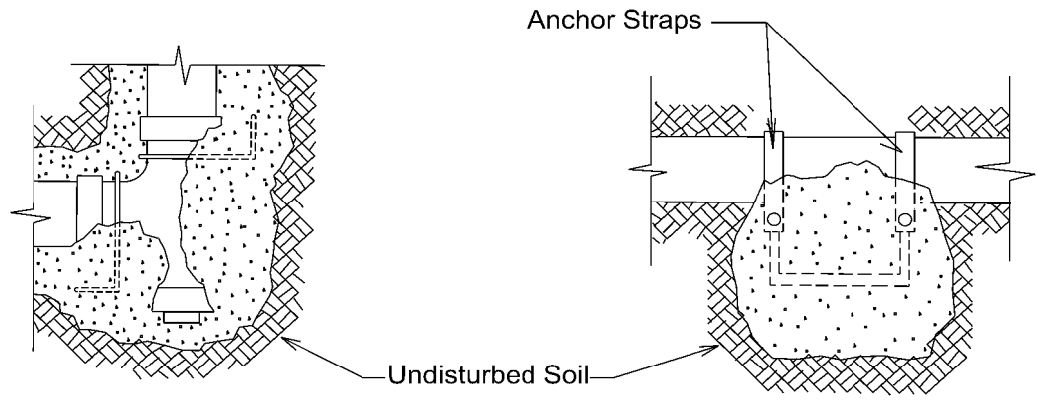
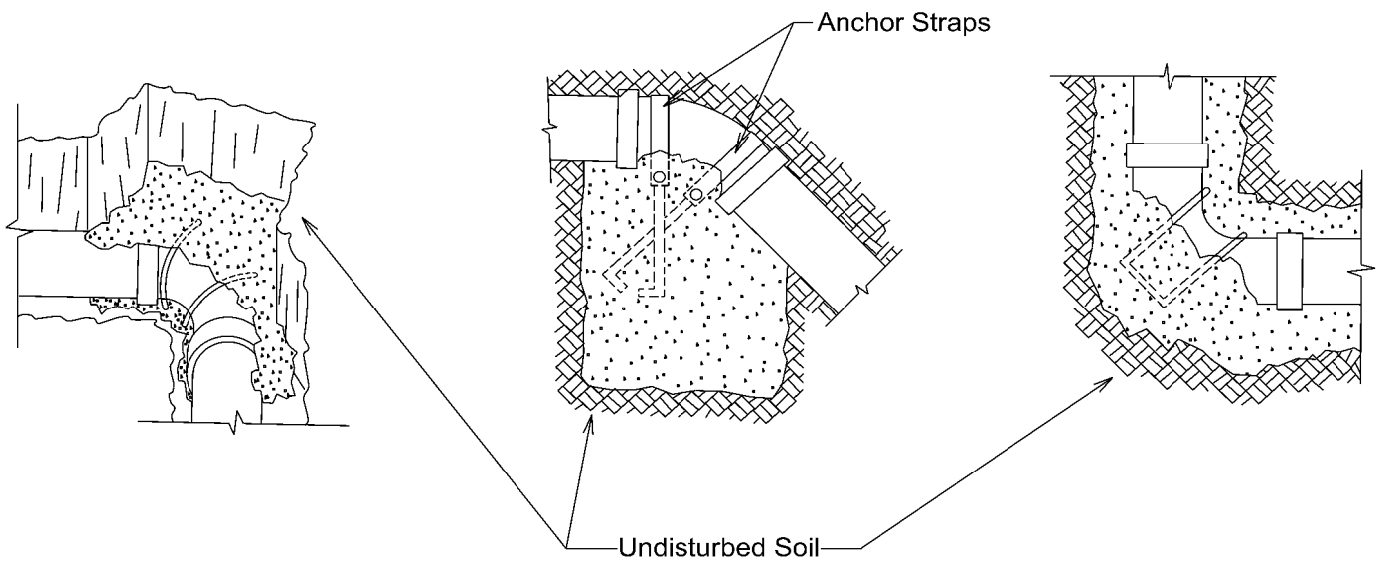

Note:  
 All concrete used for thrust blocking shall have a minimum concrete strength of 3,000 psi

PROPERTY OF <b>SAN ANTONIO WATER SYSTEM</b> SAN ANTONIO, TEXAS	TYPICAL THRUST BLOCKS ( SEWER ONLY )	APPROVED	REVISED
		March 2008	AUG 2019
		<b>DD-839-03</b>	SHEET <u>1</u> OF <u>1</u>

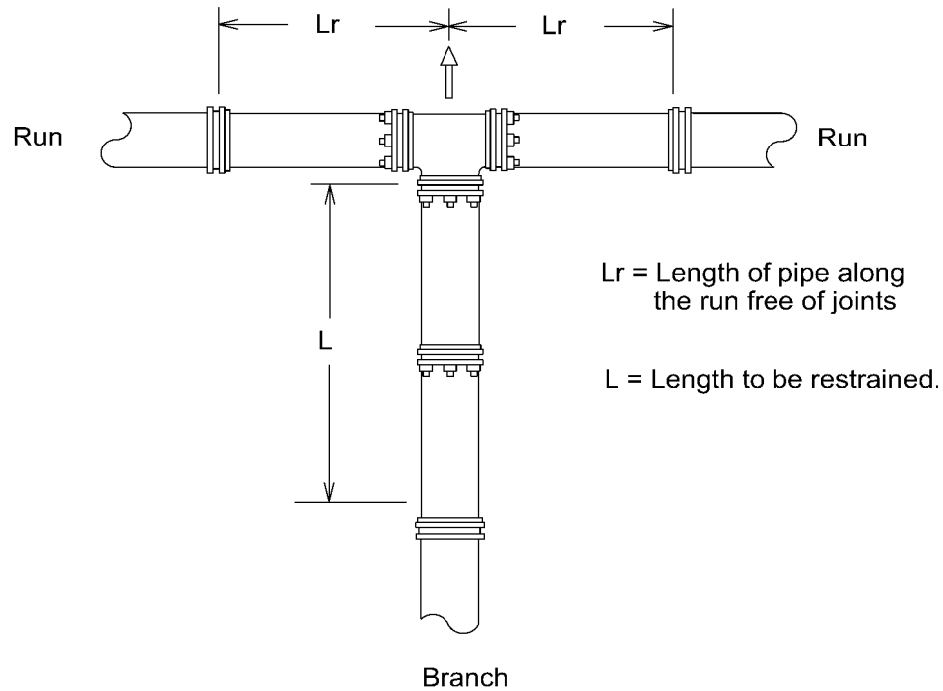

#### RESTRAINED LENGTH FOR TEES

PIPE SIZE (inch)	BRANCH SIZE (inch)	LENGTH OF RUN (ft.)	RESTRAINED LENGTH IN FEET, WHEN TEST PRESSURE = 200 psi	RESTRAINED LENGTH IN FEET, WHEN TEST PRESSURE = 150 psi
6	4	0	42	31
6	4	5	7	1
6	4	10	1	1
6	6	0	59	44
6	6	5	35	20
6	6	10	11	1
8	4	0	42	31
8	4	5	1	1
8	6	0	59	44
8	6	5	28	13
8	6	10	1	1
8	8	0	77	58
8	8	5	53	34
8	8	10	30	11
8	8	15	6	1

#### RESTRAINED LENGTH DESIGN

Restrained length calculations are for P.V.C pipe bedded in compacted granular material extending to the top of the pipe. The native soil material is assumed to be inorganic clay of high plasticity. Depth of bury is assumed to be 4 feet.

**Note:**

These calculations are provided for reference. The restrained length shall be designed based upon the conditions encountered during the installation.

PROPERTY OF <b>SAN ANTONIO WATER SYSTEM</b> SAN ANTONIO, TEXAS	<b>RESTRAINED LENGTHS FOR TEES</b>	APPROVED	REVISED
		March 2008	AUG 2019
		<b>DD-839-04</b>	
			SHEET <u>1</u> OF <u>2</u>

RESTRAINED LENGTH FOR TEES (Cont'd)

PIPE SIZE (inch)	BRANCH SIZE (inch)	LENGTH OF RUN (ft.)	RESTRAINED LENGTH IN FEET, WHEN TEST PRESSURE = 200 psi	RESTRAINED LENGTH IN FEET, WHEN TEST PRESSURE = 150 psi
12	4	0	42	31
12	4	5	1	1
12	6	0	59	44
12	6	5	13	1
12	6	10	1	1
12	8	0	77	58
12	8	5	42	23
12	8	10	7	1
12	8	15	1	1
12	12	0	109	82
12	12	5	86	59
12	12	10	63	35
12	12	15	39	12

RESTRAINED LENGTH DESIGN

Restrained length calculations are for P.V.C pipe bedded in compacted granular material extending to the top of the pipe. The native soil material is assumed to be inorganic clay of high plasticity. Depth of bury is assumed to be 4 feet.

Note:

These calculations are provided for reference. The restrained length shall be designed based upon the conditions encountered during the installation.

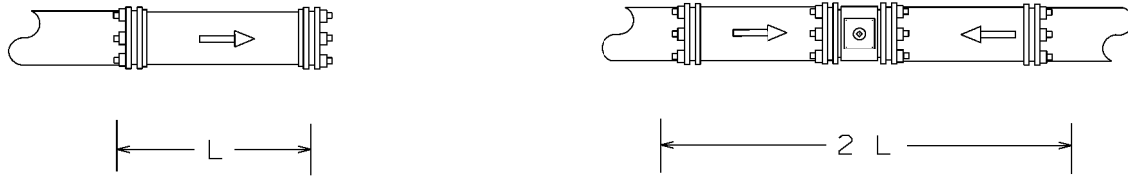

L=LENGTH TO BE RESTRAINED

PIPE SIZE (inch)	RESTRAINED LENGTH IN FEET, WHEN TEST PRESSURE = 200 psi	RESTRAINED LENGTH IN FEET, WHEN TEST PRESSURE = 150 psi
6	59	44
8	77	58
10	93	69
12	109	82

### RESTRAINED LENGTH DESIGN

Restrained length calculations are for P.V.C. pipe bedded in compacted granular material extending to the top of the pipe. The native soil material is assumed to be inorganic clay of high plasticity. Depth of bury is assumed to be 4 feet.

**Note:**

These calculations are provide for reference. The restrained length shall be designed based upon the conditions encountered during the installation.



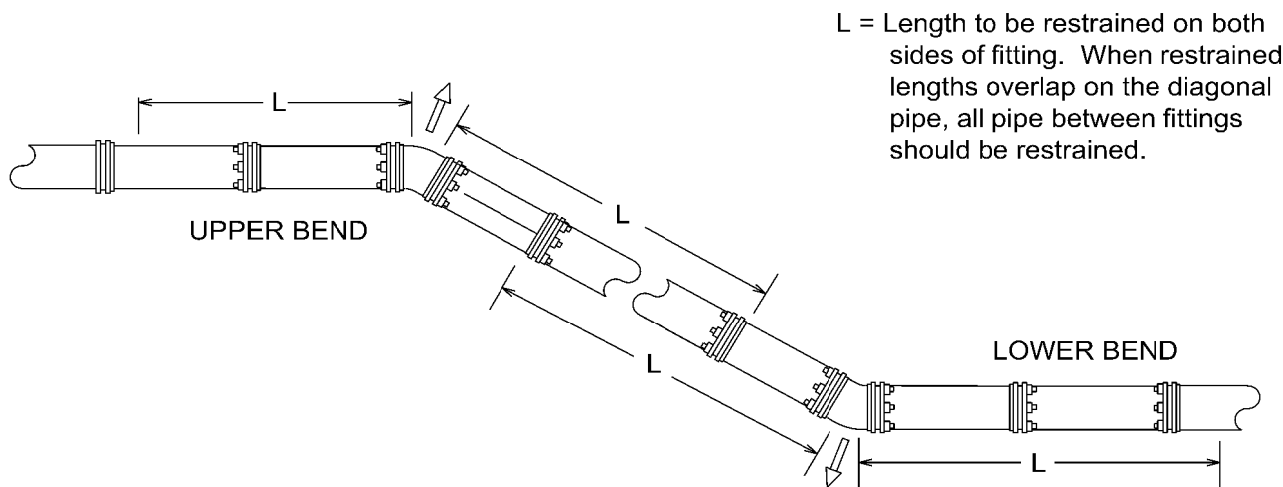

PIPE SIZE (inch)	BEND ANGLE (deg.)	LOW SIDE DEPTH	UPPER BEND RESTRAINED LENGTH IN FEET TEST PRESSURE = 200 psi	LOWER BEND RESTRAINED LENGTH IN FEET TEST PRESSURE = 200psi	UPPER BEND RESTRAINED LENGTH IN FEET TEST PRESSURE = 150 psi	LOWER BEND RESTRAINED LENGTH IN FEET TEST PRESSURE = 150 psi
6	45	5	24	8	18	6
6	22.5	5	12	4	9	3
6	11.25	5	6	2	4	1
6	45	10	24	5	18	4
6	22.5	10	12	2	9	2
6	11.25	10	6	1	4	1
8	45	5	32	11	24	8
8	22.5	5	15	5	11	4
8	11.25	5	8	3	6	2
8	45	10	32	7	24	5
8	22.5	10	15	3	11	2
8	11.25	10	8	2	6	1
12	45	5	45	16	34	12
12	22.5	5	22	7	16	6
12	11.25	5	11	4	8	3
12	45	10	45	10	34	7
12	22.5	10	22	5	16	3
12	11.25	10	11	2	8	2

**RESTRAINED LENGTH DESIGN**

Restrained length calculations are for P.V.C. pipe bedded in compacted granular material extending to the top of the pipe. The native soil material is assumed to be inorganic clay of high plasticity. Depth of bury is assumed to be 4 feet.

**Note:**

These calculations are provided for reference. The restrained length shall be designed based upon the conditions encountered during the installation.

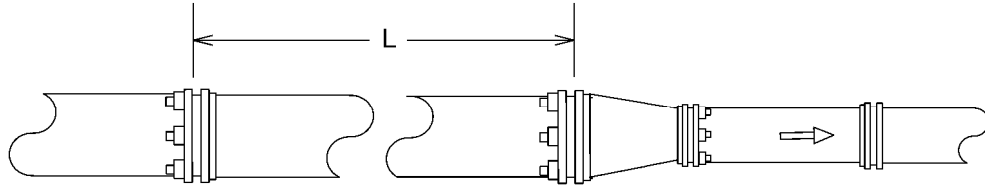

L=Length to be restrained

PIPE SIZE (inch)	SMALL SIZE (inch)	RESTRAINED LENGTH IN FEET, WHEN TEST PRESSURE = 200 psi	RESTRAINED LENGTH IN FEET, WHEN TEST PRESSURE = 150 psi
6	4	30	23
8	4	55	42
8	6	32	24
12	4	95	71
12	6	80	60
12	8	58	43

#### RESTRAINED LENGTH DESIGN

Restrained length calculations are for P.V.C. pipe bedded in compacted granular material extending to the top of the pipe. The native soil material is assumed to be inorganic clay of high plasticity. Depth of bury is assumed to be 4 feet.

**Note:**

These calculations are provided for reference. Th restrained length shall be designed based upon the conditions encountered during the installation.

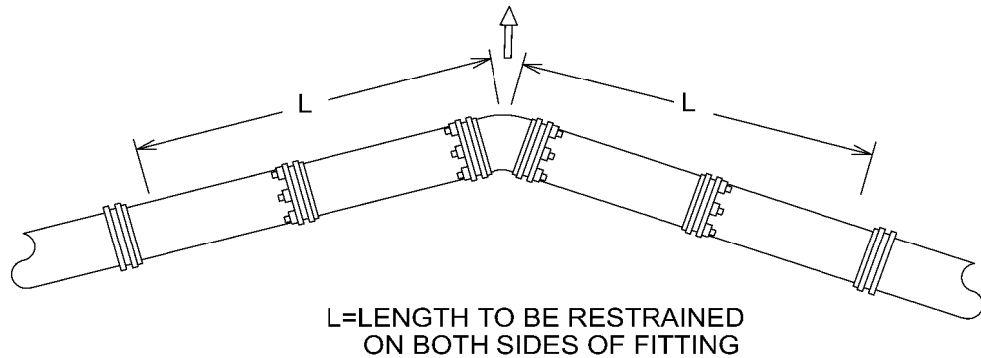

PIPE SIZE (inch)	BEND ANGLE (deg)	RESTRAINED LENGTH IN FEET, WHEN TEST PRESSURE = 200 psi	RESTRAINED LENGTH IN FEET, WHEN TEST PRESSURE = 150 psi
6	90	23	17
6	45	9	7
6	22.5	5	3
6	11.25	2	2
8	90	30	22
8	45	12	9
8	22.5	6	4
8	11.25	3	2
12	90	43	32
12	45	18	13
12	22.5	8	6
12	11.25	4	3

#### RESTRAINED LENGTH DESIGN

Restrained length calculations are for P.V.C pipe bedded in compacted granular material extending to the top of the pipe. The native soil material is assumed to be inorganic clay of high plasticity. Depth of bury is assumed to be 4 feet.

**Note:**

These calculations are provided for reference. The restrained length shall be designed based upon the conditions encountered during the installation.